



BILTMORE

arpaitalia
hotel supplies

ALISEO GERMANY
HOTELPERFEKTION



Standmodell	Free standing
Planspiegel mit 10-fach-Vergrößerungsausschnitt	Plain mirror with 10 x circular insert
Facettenschliff	Facette cut
Kugelgelenk	Full pivotal adjustment
Material: Messing	Material: brass

Art.	Ausführung	Finish	
rund		round	
020587	chrom	chrome	ø 255 mm
elliptisch		elliptical	
020588	chrom	chrome	200 x 300 mm

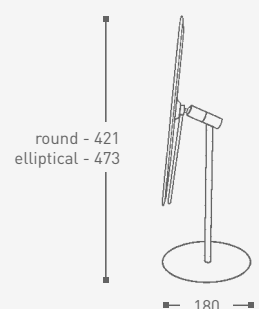



Wandmontage
2 Spiegel: Plan- und
3-fach-Vergrößerung
Material: Messing

Wall mount
2 mirrors: plain and
3 x magnification
Material: brass

Art.	Ausführung	Finish	
rund		round	
020568	chrom	chrome	ø 200 mm
elliptisch		elliptical	
020509	chrom	chrome	230 x 180 mm

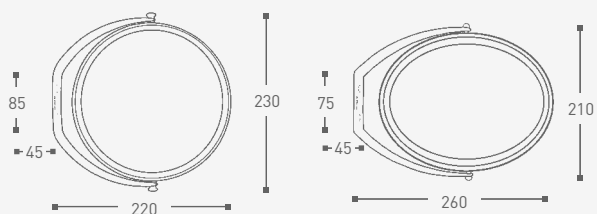

COSMO



Schwenkarm
3-fach-Vergrößerung
Verdeckte Montageeinheit
Kippgelenk
Material: Messing

Single arm
3 x magnification
Covered backplate
Full pivotal adjustment
Material: brass

Art.	Ausführung	Finish	
020607	chrom	chrome	ø 200 mm

7
85
↓

— 214 —



Standmodell	Free standing
3-fach-Vergrößerung	3 x magnification
Kugelgelenk	Full pivotal adjustment
Material: Messing	Material: brass

Art.	Ausführung	Finish	
020488	chrom	chrome	ø 200 mm

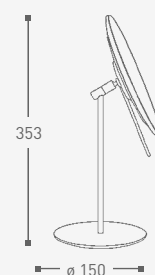

LUNA



Schwenkarm	Single/twin arm
3-fach-Vergrößerung	3 x magnification
Verdeckte Montageeinheit	Covered backplate
Doppelwalzengelenk	Full pivotal adjustment
Material: Messing	Material: brass

Art.	Ausführung	Finish	
am einfachen Schwenkarm	on single arm	chrome	ø 240 mm
020598	chrom	chrome	
am Doppel-Schwenkarm	on twin arm	chrome	ø 240 mm
020599	chrom	chrome	

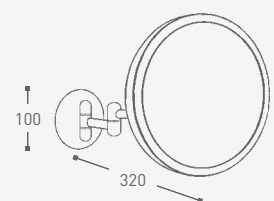
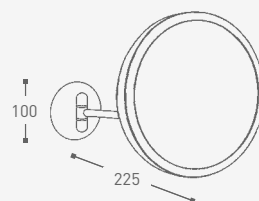

COSMO

Schwenkarm - SWAN
2 Spiegel: Plan- und
3-fach-Vergrößerung
Verdeckte Montageeinheit
Material: Messing

Single arm SWAN
2 mirrors: plain and
3 x magnification
Covered backplate
Material: brass

Art.	Ausführung	Finish	
020611	chrom	chrome	ø 200 mm

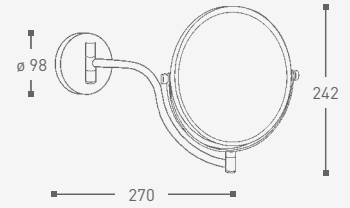

SWAN



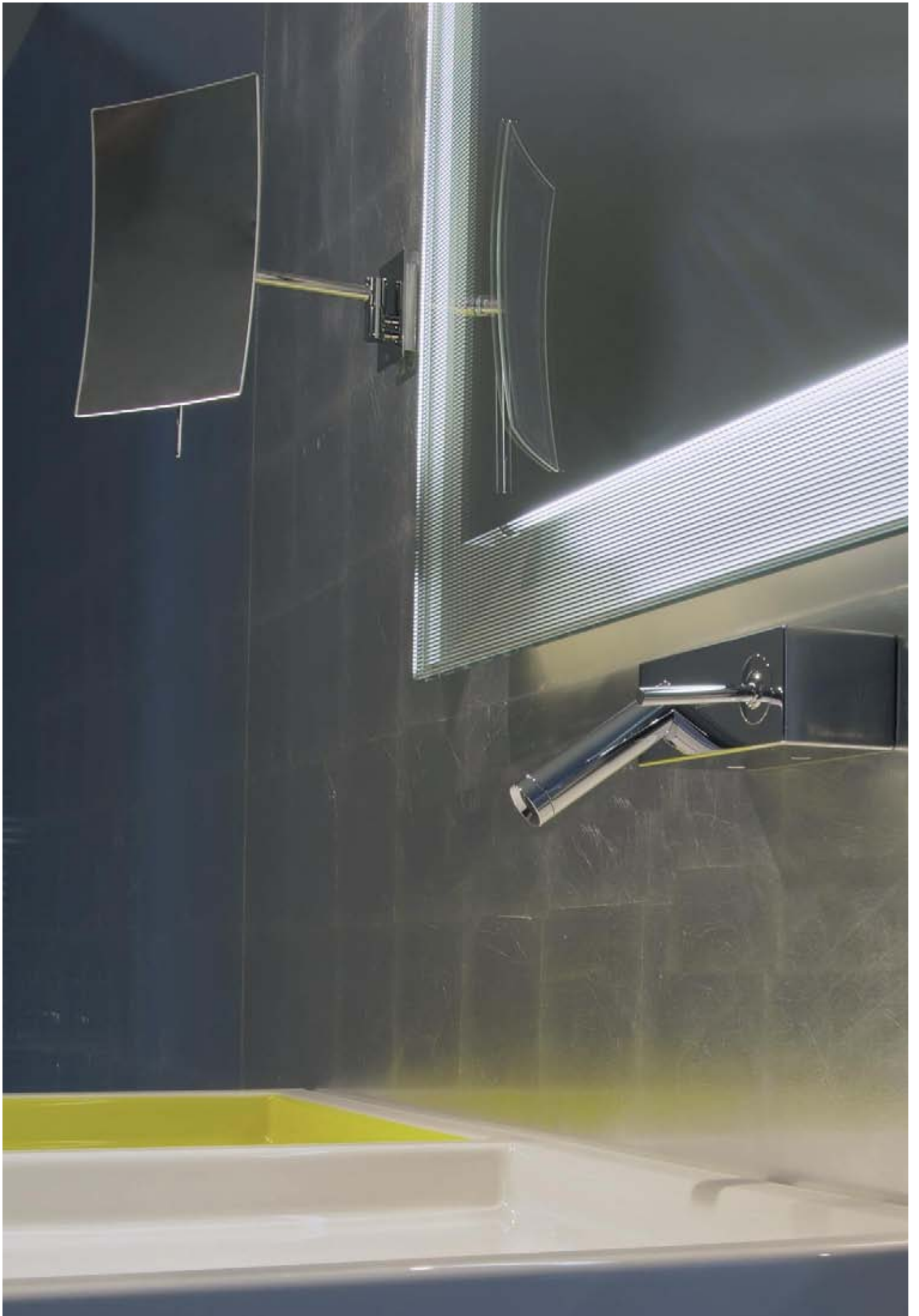



Standmodell
 Planspiegel mit 10-fach-
 Vergrößerungsausschnitt
 Facettenschliff
 Kugelgelenk
 Material: Messing

Free standing
 Plain mirror with
 10 x circular insert
 Facette cut
 Full pivotal adjustment
 Material: brass

Art.	Ausführung	Finish	
020586	chrom	chrome	200 x 300 mm

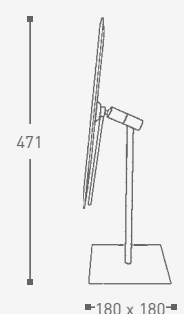

COSMO



Schwenkarm / Standmodell Single arm / free standing
 3-fach-Vergrößerung 3 x magnification
 Verdeckte Montageeinheit Covered backplate
 Kipp-/Kugelgelenk Full pivotal adjustment
 Material: Messing Material: brass

Art.	Ausführung	Finish	
am Schwenkarm		on single arm	
020563	chrom	chrome	160 x 240 mm
Standmodell		free standing	
020500	chrom	chrome	130 x 200 mm
020564	chrom	chrome	160 x 240 mm

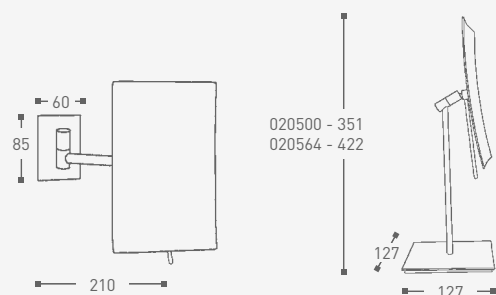

COSMO



QUARZO

Wandstange
3-fach-Vergrößerung
Verdeckte Schrauben
Kugelgelenk
Material: Messing

Wall bar
3 x magnification
Covered screws
Full pivotal adjustment
Material: brass

Art.	Ausführung	Finish
an Wandstange 'Quarzo'		on wall bar 'Quarzo'
020577	chrom	chrome 215 x 215 mm
an Wandstange 'Diamant'		on wall bar 'Diamant'
020578	chrom	chrome 215 x 215 mm

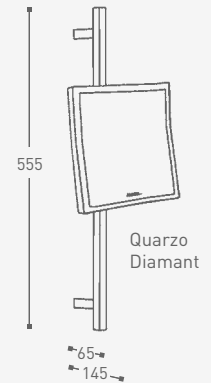

Höhenverstellbarer Gleiter
Sure-grip lock-in system



DIAMANT

COSMO



Wandmontage / Standmodell Wall mount / free standing
 2 Spiegel: Plan- und 2 mirrors: plain and
 3-fach-Vergrößerung 3 x magnification
 Material: Messing Material: brass

Art.	Ausführung	Finish
Wandmontage		wall mount
020608	chrom	chrome 200 x 200 mm
Standmodell		free standing
020603	chrom	chrome 200 x 200 mm

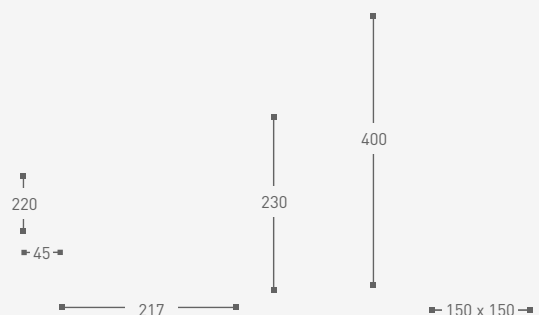

COSMO



Schwenkarm
2 Spiegel: Plan- und
3-fach-Vergrößerung
Verdeckte Montageeinheit
Material: Messing

Singel/twin arm
2 mirrors: plain and
3 x magnification
Covered backplate
Material: brass

Art.	Ausführung	Finish	
	am einfachen Schwenkarm	on single arm	
020605	chrom	chrome	200 x 200 mm
	am verkürzten Doppel-Schwenkarm /	on shortened twin arm	
020604	chrom	chrome	200 x 200 mm

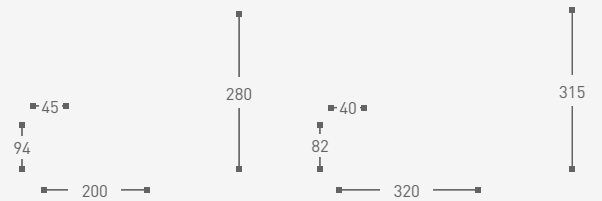



NOSTALGIE



Verdeckte Schrauben -
Solide Konstruktion

Covered Screws -
Clean Classy Design

Doppelscherenarm
2 Spiegel: Plan- und
3-fach-Vergrößerung
Verdeckte Schrauben
Material: Messing

Twin scissor arm
2 mirrors: plain and
3 x magnification
Covered screws
Material: brass

Art.	Ausführung	Finish	
020458	chrom	chrome	ø 200 mm

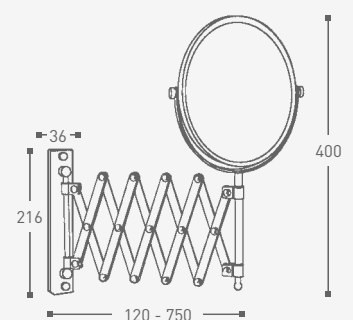

NOSTALGIE



Schwenkarm / Standmodell
 2 Spiegel: Plan- und
 3-fach-Vergrößerung
 Verdeckte Montageeinheit
 Material: Messing

Single arm / free standing
 2 mirrors: plain and
 3 x magnification
 Covered backplate
 Material: brass

Art.	Ausführung	Finish
am Schwenkarm		on single arm
020487	chrom	chrome 200 x 200 mm
Standmodell		free standing
020498	chrom	chrome 200 x 200 mm

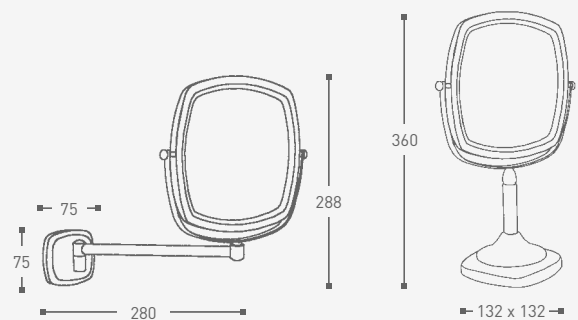

NOSTALGIE



Wandsockel
2 Spiegel: Plan- und
3-fach-Vergrößerung
Verdeckte Montageeinheit
Kugelgelenk
Material: Messing

Wall mount
2 mirrors: plain and
3 x magnification
Covered backplate
Full pivotal adjustment
Material: brass

Art.	Ausführung	Finish	
020494	chrom	chrome	ø 200 mm

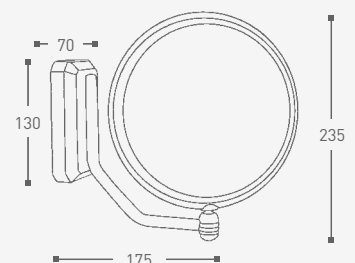

NOSTALGIE

Standmodell
2 Spiegel: Plan- und
3-fach-Vergrößerung
Material: Messing

Free standing
2 mirrors: plain and
3 x magnification
Material: brass

Art.	Ausführung	Finish	
020496	chrom	chrome	ø 250 mm

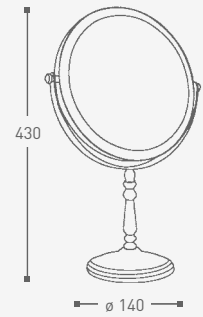

NOSTALGIE



Schwenkarm
2 Spiegel: Plan- und
3-fach-Vergrößerung
Verdeckte Montageeinheit
Material: Messing

Single arm
2 mirrors: plain and
3 x magnification
Covered backplate
Material: brass

Art.	Ausführung	Finish	
020567	chrom	chrome	ø 200 mm

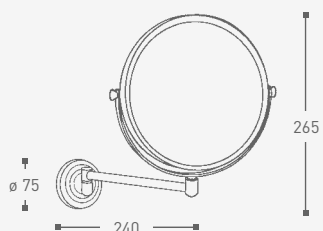

NOSTALGIE



Wandstange 'Nostalgie'
3-fach-Vergrößerung
Verdeckte Schrauben
Kugelgelenk
Material: Messing

Wall bar 'Nostalgie'
3 x magnification
Covered screws
Full pivotal adjustment
Material: brass

Art.	Ausführung	Finish	
020286	chrom	chrome	ø 230 mm

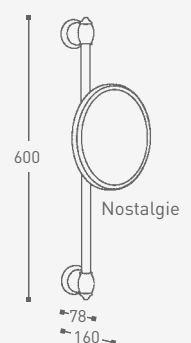

PROJECT



SLIM



CLASSIC

Wandstange
3-fach-Vergrößerung
Verdeckte Schrauben
Kugelgelenk
Material: Messing

Wall bar
3 x magnification
Covered screws
Full pivotal adjustment
Material: brass

Art.	Ausführung	Finish
an Wandstange 'Slim'		on wall bar 'Slim'
020614	chrom	chrome ø 200 mm
an Wandstange 'Classic'		on wall bar 'Classic'
020049	chrom	chrome ø 230 mm

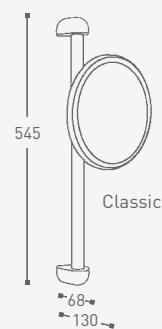



SEATRA



SABA

Wandstange
3-fach-Vergrößerung
Verdeckte Schrauben
Kugelgelenk
Material Stange: Messing

Wall bar
3 x magnification
Covered screws
Full pivotal adjustment
Material bar: brass

Art.	Ausführung	Finish
an Wandstange 'Seatra'		on wall bar 'Seatra'
Spiegel: Messing		Mirror: brass
020047	chrom	chrome ø 230 mm
an Wandstange 'Saba'		on wall bar 'Saba'
Spiegel: ABS-Kunststoff		Mirror: ABS-plastic
020011	chrom	chrome ø 190 mm
020012	chrom	chrome ø 220 mm

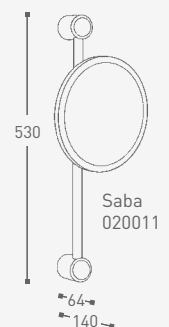
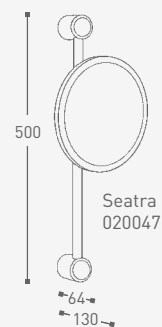



PROJECT

Schwenkarm
 2 Spiegel: Plan- und
 3-fach-Vergrößerung
 Verdeckte Montageeinheit
 Material: Messing

Singel/twin arm
 2 mirrors: plain and
 3 x magnification
 Covered backplate
 Material: brass

Art.	Ausführung	Finish	
	am einfachen Schwenkarm	on single arm	
020569	chrom	chrome	ø 200 mm
	am verkürzten Doppel-Schwenkarm /	on shortened twin arm	
020570	chrom	chrome	ø 200 mm

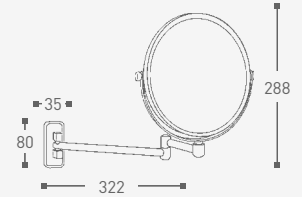
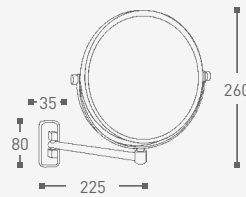

PROJECT



Schwenkarm
 2 Spiegel: Plan- und
 3-fach-Vergrößerung
 Höhenverstellbar
 Verdeckte Montageeinheit
 Material: Messing

Single arm
 2 mirrors: plain and
 3 x magnification
 Height adjustable
 Covered backplate
 Material: brass

Art.	Ausführung	Finish	
020597	chrom	chrome	ø 200 mm

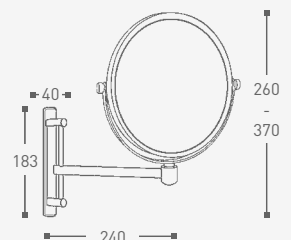

PROJECT

Schwenkarm
 2 Spiegel: Plan- und
 3-fach-Vergrößerung
 Verdeckte Montageeinheit
 Material: Messing

Single/twin arm
 2 mirrors: plain and
 3 x magnification
 Covered backplate
 Material: brass

Art.	Ausführung	Finish	
am einfachen Schwenkarm		on single arm	
020506	chrom	chrome	ø 200 mm
am Doppel-Schwenkarm		on twin arm	
020507	chrom	chrome	ø 200 mm

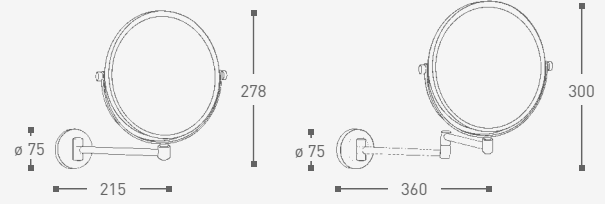



Schwenkarm / Standmodell	Single arm / free standing
2 Spiegel: Plan- und	2 mirrors: plain and
3-fach-Vergrößerung	3 x magnification
Verdeckte Montageeinheit	Covered backplate
Material: Messing	Material: brass

Art.	Ausführung	Finish
am Schwenkarm		on single arm
020486	chrom	chrome ø 200 mm
Standmodell		free standing
020499	chrom	chrome ø 200 mm

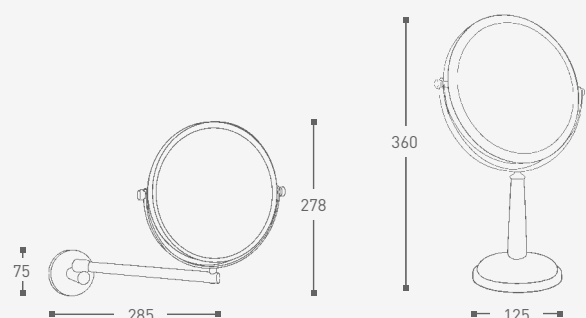

PROJECT



Schwenkarm
2 Spiegel: Plan- und
3-fach-Vergrößerung
Verdeckte Schrauben
Material: Messing

Single / twin arm
2 mirrors: plain and
3 x magnification
Covered screws
Material: brass

Art.	Ausführung	Finish
am Schwenkarm		on single arm
020490	chrom	chrome ø 200 mm
am verkürzten Doppel-Schwenkarm /		on shortened twin arm
020491	chrom	chrome ø 200 mm
am Doppelschwenkarm		on twin arm
020492	chrom	chrome ø 200 mm

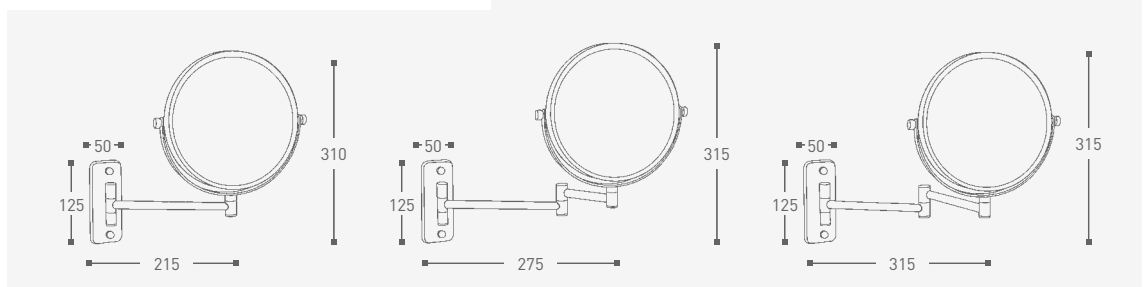

PROJECT



Schwenkarm / Wandsockel
3-fach-Vergrößerung
Verdeckte Montageeinheit
Kugelgelenk
Material: Messing oder
ABS-Kunststoff

Single arm / wall mount
3 x magnification
Covered backplate
Full pivotal adjustment
Material: brass or
ABS-plastic

Art.	Ausführung	Finish	
am Schwenkarm		On single arm	
Material: Messing		Material: brass	
020405	chrom	chrome	ø 220 mm
am Wandsockel		Wall mount	
Material: ABS-Kunststoff		Material: ABS-plastic	
020002	chrom	chrome	ø 190 mm
020004	chrom	chrome	ø 220 mm
020003	weiß	white	ø 190 mm
020005	weiß	white	ø 220 mm

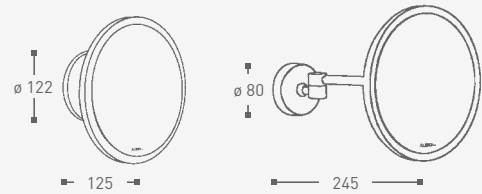

PROJECT



Zum Aufkleben
3-fach-Vergrößerung

Adhesive
3 x magnification

Art.	Ausführung	Finish	
020001	mit Kunststoffring glasklar	with plastic ring clear	ø 170 mm
020606	mit Messingring chrom	with brass ring chrome	ø 200 mm

